

Struttura portante: in legno massello e multistrato monoscocca con molleggio garantito da cinghie elastiche ad alta componente di caucciù.

Preparazione della struttura: in poliuretano espanso a quote differenziate ad alta densità e resilienza. Layer superiore di seduta in poliuretano espanso speciale MEMOSOFF. Ulteriore rivestimento della struttura in microfibra "Hi-tex", accoppiata con vellutino.

Schienali mobili: realizzati con 3 differenti parti in poliuretano sagomate a controllo numerico, a densità differenziata, ad alta resilienza. All'interno dell'assemblaggio delle imbottiture è predisposta una lastra d'acciaio che equilibra il manufatto. Ulteriore rivestimento dello schienale con fibra di poliestere termolegata, accoppiata con vellutino. Alla base dello schienale è predisposto, unito al rivestimento, uno speciale elastomero di derivazione nautica che permette l'ancoraggio per attrito.

Braccioli mobili: realizzati in poliuretano a densità differenziata. All'interno dell'assemblaggio delle imbottiture è predisposta una lastra d'acciaio che equilibra il manufatto. Ulteriore rivestimento del bracciolo con fibra di poliestere termolegata accoppiata con vellutino. Alla base del bracciolo è predisposto, unito al rivestimento, uno speciale elastomero di derivazione nautica che permette l'ancoraggio per attrito.

Cuscini schienale: totalmente imbottiti in microfibra "Hi-tex" canalizzata, di ultima generazione. Cuscini schienali poggiatesta con inserto ergonomico in poliuretano espanso sagomato a controllo numerico.

Sfoderabilità: rivestimento sfoderabile in tutte le versioni (tessuto e pelli soft touch).

Basamento: esclusivi basamenti in alluminio e acciaio. Il piede in estruso d'alluminio dona leggerezza mentre la slitta a terra in acciaio speciale ad alta componente di carbonio garantisce resistenza, stabilità ed elasticità. Disponibile nella finitura Peltro.

Structure: in solid wood and plywood, monocoque with high natural rubber content elastic strap webbing.

Preparation of the seat: in high resilience variable-density polyurethane foam. Upper layer with special polyurethane foam MEMOSOFF. Outer covering with "Hi-tex" microfiber laminated to technical fiber.

Movable backrest: made with 3 different high resilience polyurethane parts shaped under numerical control. Backrest construction has inside a metal plate. Additional cover in heat-bonded polyester fiber laminated to technical fiber. Thanks to a special nautical elastomer fixed with the cover, backrest attach on the base.

Movable armrest: in variable-density polyurethane foam. Armrest construction has inside a metal plate. An additional cover in heat-bonded polyester fiber laminated to technical fiber. Thanks to a special nautical elastomer fixed with the cover, armrest attach on the base.

Back cushion: channeled "Hi-tex", a last generation microfiber certificated OEKO-TEX STANDARD 100, fire resistant, 100% recyclable. Backrest cushion with headrest has ergonomic insert in polyurethane foam shaped under numerical control.

Covers: completely removable in all version (fabric and leather soft touch).

Base: exclusive extruded aluminum and carbon steel bases. Available painted Pewter.

FILIPH AIR

Dimensioni e altezze di seduta
Sitting depth and sofa height

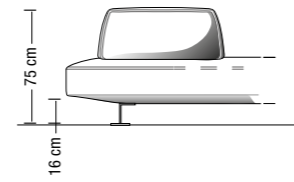

Altezza cuscino orizzontale
Horizontal backrest cushion

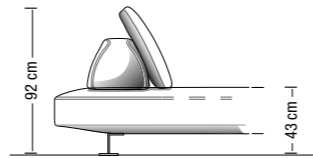

Altezza cuscino poggiatesta
Backrest cushion with headrest

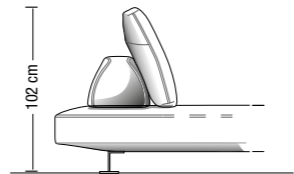

reddot design award
winner 2018

Sono disponibili misure speciali su richiesta.
I disegni a catalogo sono da considerarsi suggerimenti di configurazione:
schienali e cuscini sono elementi liberamente abbinabili.

Custom-made elements are available on request.
Drawings are configuration suggestions:
backrests and cushions are freely combinable elements.

Divano da 125 cm
Sofa 125 cm

FA125

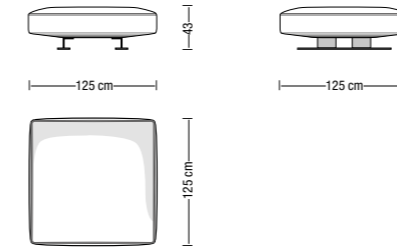

Esempio di disposizione di schienale mobile
Movable backrest placement example

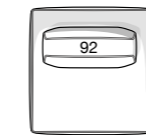

Divano da 175 cm
Sofa 175 cm

FA175

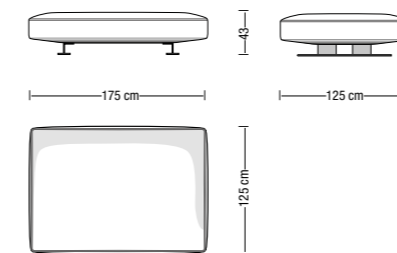

Esempi di disposizione di schienali mobili
Movable backrests placement examples

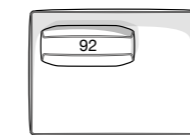
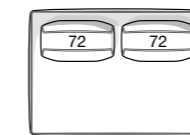

Divano da 195 cm
Sofa 195 cm

FA195

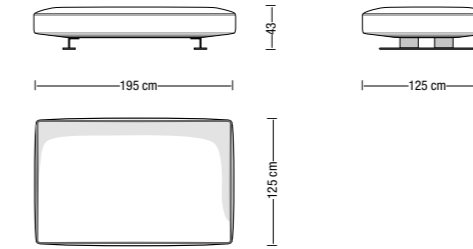

Esempi di disposizione di schienali mobili
Movable backrests placement examples

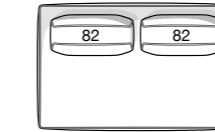
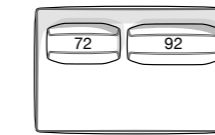

Divano da 225 cm
Sofa 225 cm

FA225

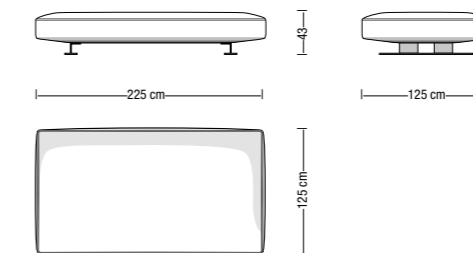

Esempio di disposizione di schienali mobili
Movable backrests placement example



Divano da 255 cm
Sofa 255 cm

FA255

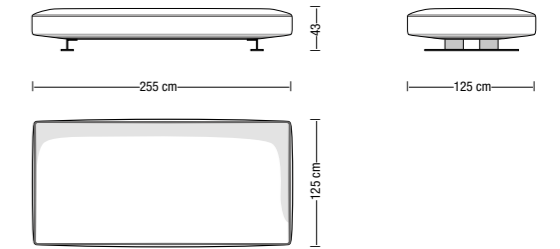

Esempi di disposizione di schienali mobili
Movable backrests placement examples

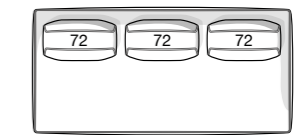

Divano da 285 cm
Sofa 285 cm

FA285

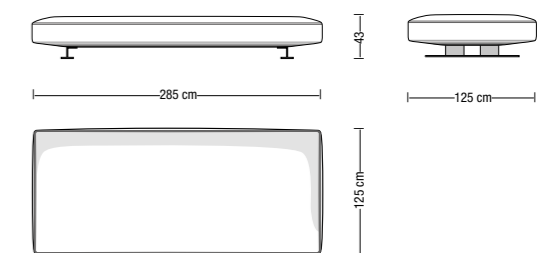

Esempi di disposizione di schienali mobili
Movable backrests placement examples



Divano da 110x110 cm
Sofa 110x110 cm

FA110X

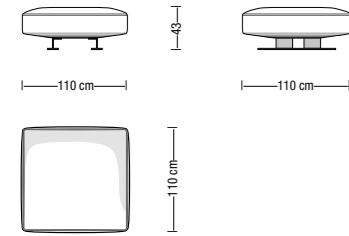

Esempio di disposizione di schienale mobile
Movable backrest placement example

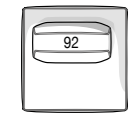

Divano da 175x110 cm
Sofa 175x110 cm

FA175X

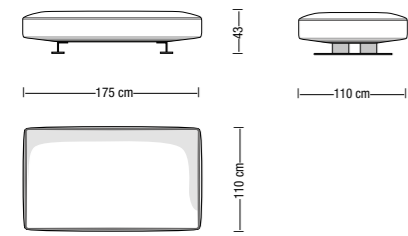

Esempi di disposizione di schienali mobili
Movable backrests placement examples

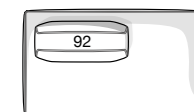
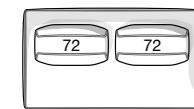

Divano da 195x110 cm
Sofa 195x110 cm

FA195X

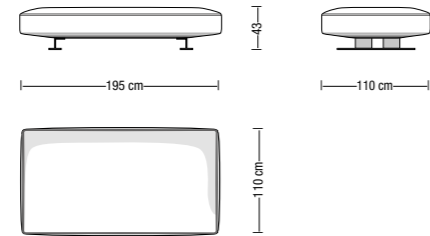

Esempi di disposizione di schienali mobili
Movable backrests placement examples

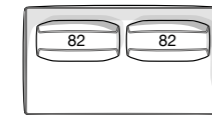
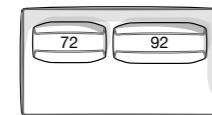

Divano da 225x110 cm
Sofa 225x110 cm

FA225X

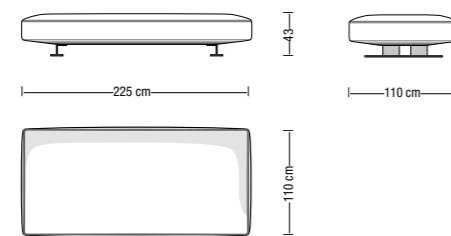

Esempio di disposizione di schienali mobili
Movable backrests placement example

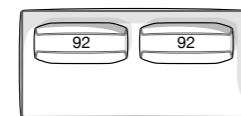

Divano da 255x110 cm
Sofa 255x110 cm

FA255X

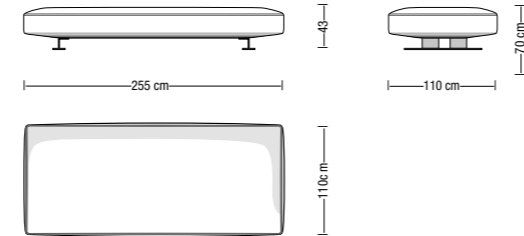

Esempi di disposizione di schienali mobili
Movable backrests placement examples

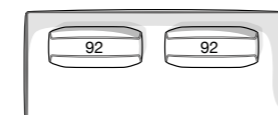
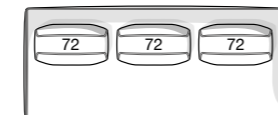

Divano trapezoidale da 210x122 cm
Trapezoidal sofa 210x122 cm

FA210W

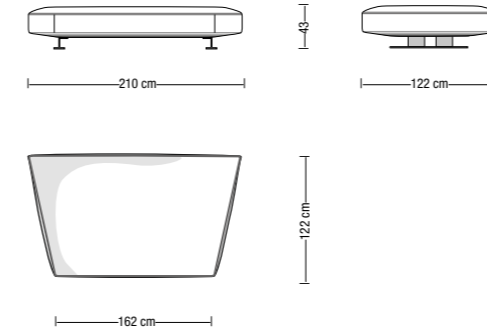

Chaise-longue trapezoidale da 138x175 cm
Trapezoidal chaise-longue 138x175 cm

FA138CLW

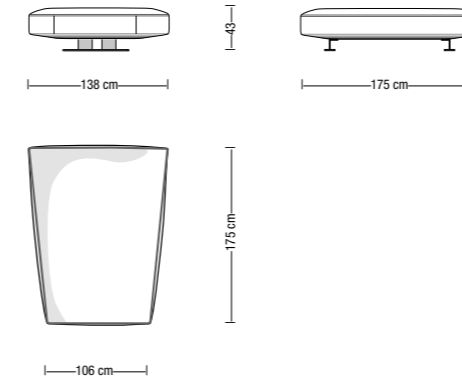

Esempio di disposizioni schienale mobile
movable backrest placement example

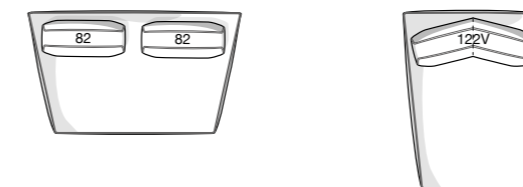

Divano Pentagonale
Pentagonal Sofa

FA5

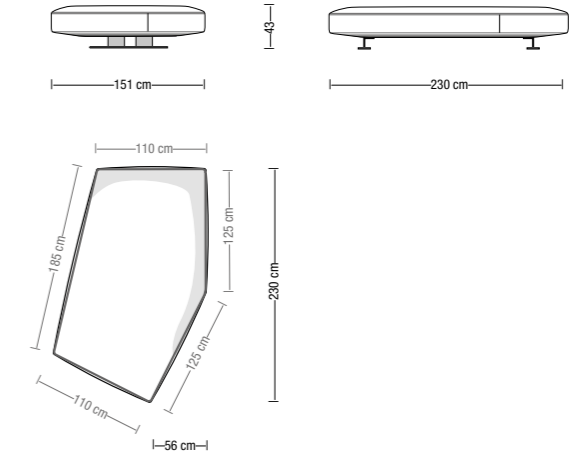

Configurazioni divano pentagonale ed esempi di disposizioni schienale mobile
Pentagonal sofa layouts and movable backrest placement example

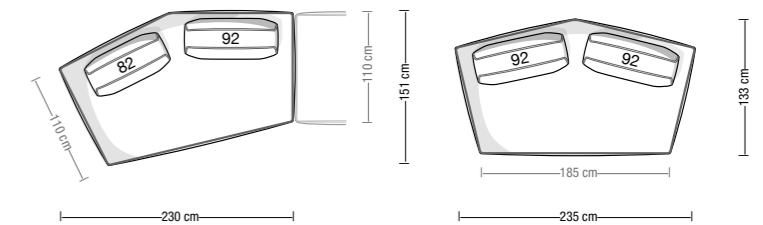
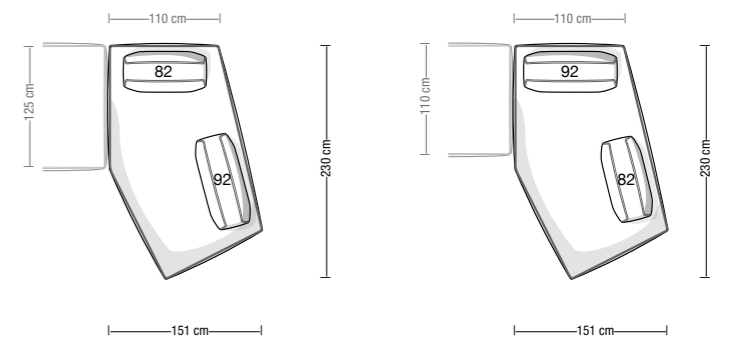

Schienali mobili
Movable backrests

Schienale mobile 72
Movable backrest 72

FLM72

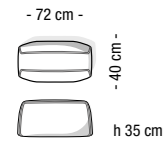

Schienale mobile 82
Movable backrest 82

FLM82

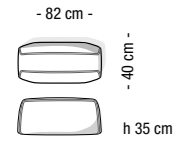

Schienale mobile 92
Movable backrest 92

FLM92

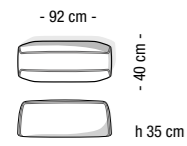

Schienale mobile 122V
Movable backrest 122V

FLM122V

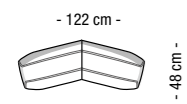

Cuscini - Schienali
Backrests

Cuscino schienale poggiatesta
Backrest cushion headrest

FLSPT

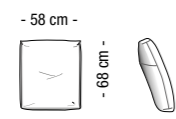

Bracciolo mobile
Movable armrest

FLB

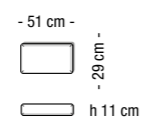

Cuscino schienale orizzontale
Horizontal backrest

FLSO

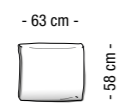

Cuscino schienale verticale
Vertical backrest

FLSV

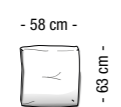

Poggiareni
Lumbar rest

FLP

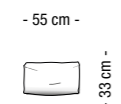

Pouf Filiph Air
Filiph Air ottomans

Pouf da 63x53 cm
Ottoman 63x53 cm

FA63X53

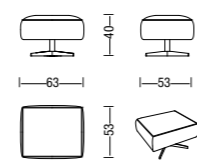

Pouf abbinabili a Filiph Air
Ottomans matchable with Filiph Air

Pouf Love 63 cm
Ottoman Love 63 cm

LV63P

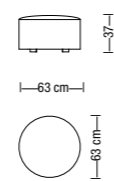

Pouf Love 83 cm
Ottoman Love 83 cm

LV83P

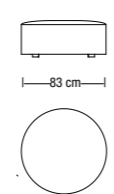

Composizioni suggerite
Compositions suggested

FA1 255 x 125 cm

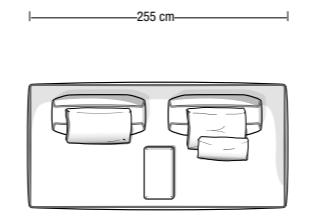

FA2 320 x 195 cm

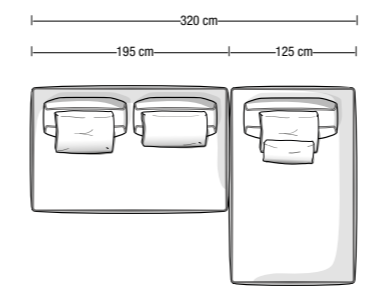

FA3 350 x 225 cm

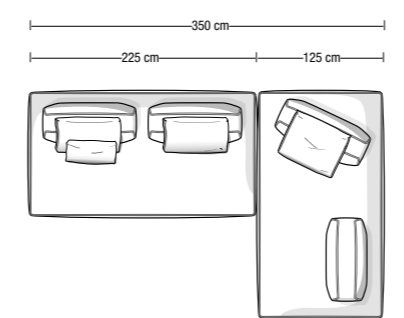

FA4 350 x 350 cm

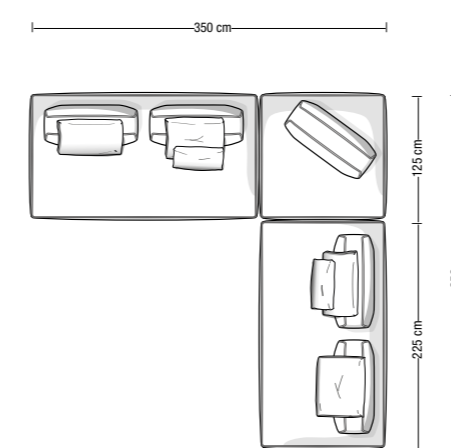

FA5 256-346 x 175-204 cm

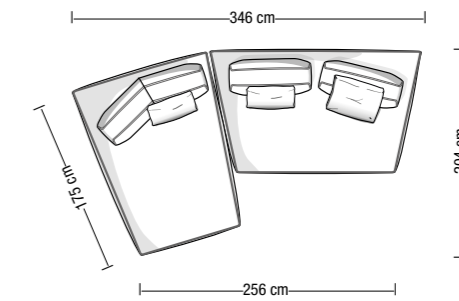

FA6 335-376 x 230 cm

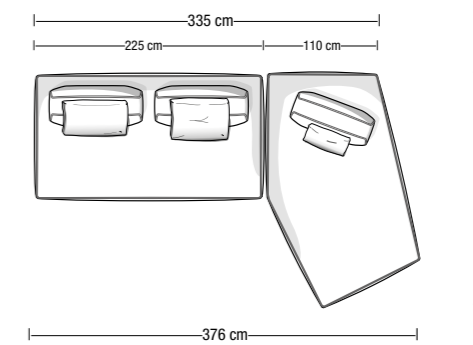

FA7 359 x 230 cm

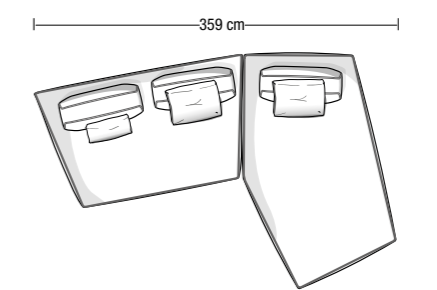

FAB 414 x 156 cm

